

# PRODUCT SPECIFICATION

A

- 1. PRODUCT : TOUCH PANEL
- 2. PART NUMBER : **TTI : T010-1301-T962**  
**Customer:**
- 3. ATTACHED DRAWING : **Tech Bes TTI-11002**

B

SIGNATURE FOR YOUR RECEIPT
DATE:

C

TRANSTOUCH TECHNOLOGY INC. (TTI)  
DOCUMENT No. : TTI PRODUCT TECHNOLOGY Dept.

D

MANAGER : \_\_\_\_\_ DATE: \_\_\_\_\_

TTI PRODUCT TECHNOLOGY Dept.  
3F No.50 Hwa-Ya 3<sup>rd</sup> Road ,Kwei-san Shian Tao-yuan ,Taiwan  
TEL(03)3978800 FAX(03)3978855

**PROPRIETARY NOTE**  
This document contains information confidential and proprietary to TRANSTOUCH TECHNOLOGY INC. (TTI) and shall not be reproduced or transferred to other documents or disclosed to other or used for any purpose other than for witch it was obtained without the expressed written consent of TRANSTOUCH TECHNOLOGY INC. (TTI)

E

原圖管理元  
↑  
日付

					Title: Touch Panel Spec.	
					Draw No. Tech Bes TTI-11002	
					Cust	
ED	Date	Design	Check	Description		富晶通科技股份有限公司 Transtouch Technology Inc.
Des	20120704	Cloud	Chk		App.	
					SHEET	1/18

F

觸控面板製品規格書

**TOUCH PANEL SPECIFICATION**

富晶通科技股份有限公司  
TRANSTOUCH TECHNOLOGY INC.

深圳市长盛威光电技术有限公司  
www.szlongsun.net

原圖管理元	↑
日付	

					Title: Touch Panel Spec.	
					Draw No. Tech Bes TTI-11002	
					Cust	
ED	Date	Design	Check	Description		
Des	20120704	Cloud	Chk		App.	
					富晶通科技股份有限公司 Transtouch Technology Inc.	
					SHEET	2/18

觸控面板製品規格書  
TOUCH PANEL SPECIFICATION

A

1. 適用範圍 Application

此規格書是適用富晶通科技股份有限公司所製作的觸控面板。  
This specification is applied to TOUCH PANEL made by  
TRANSTOUCH TECHNOLOGY INC. (TTI)。

【製品圖號 Product No.】

品名 Name	製品圖號 P/No.	尺寸 Size	備註 Remark
觸控面板 TOUCH PANEL	T010-1301-T962	7	筆/指輸入兼用 for pen & finger input (RoHS)

B

2. 概要 Function

此製品是裝置在 LCD 等平面顯示器上使用電阻薄膜的觸控面板。以先端有小 R 的筆或是以手指按下觸控面板的表面，觸控面板的電壓會透過檢出迴路將座標值檢測出來。  
TTI TOUCH PANEL is resistance type that customer uses with flat display like LCD. Once operator touches it by resin PEN with round end or FINGER, the circuit for TOUCH PANEL sends coordinate point to PC from voltage at contact point.

C

3. 製造者 Manufacturer

富晶通科技股份有限公司 TRANSTOUCH TECHNOLOGY INC. (TTI)  
所在地:桃園縣龜山鄉(華亞科技園區)華亞三路 50 號 3 樓  
Address:3F No.50 Hwa-Ya 3<sup>rd</sup> Road ,Kwei-san Shian Tao-yuan ,Taiwan

D

4. 外型 Outline

4.1 外型圖 Drawing

參考最後附加圖面  
Please refer the last page of this spec.

原圖管理元  
↑  
日付

					Title: Touch Panel Spec.	
					Draw No. Tech Bes TTI-11002	
					Cust	
ED	Date	Design	Check	Description		富晶通科技股份有限公司 Transtouch Technology Inc.
Des	20120704	Cloud	Chk	App.		
					SHEET	3/18

A

B

C

D

E

F

4.2 用語定義 Defines of words

用 語 Words	定 義 Defines
動作保證範圍 Guaranteed active area	觸控面板的特性保證範圍。 An area to be guaranteed all characteristics stated on this spec.
上蓋邊界 Boundary line of top enclosure	表示上蓋外框的建議位置。 Recommended boundary line of top enclosure
透明範圍 View (transparent) area	雙面膠或是從電極內側的透明範圍。 A view area which is inside adhesive zone or electrode pattern. Top enclosure must not be fixed by this area.
誤輸入防止範圍 Touch undetected	在透明絕緣的範圍上，防止上蓋邊緣的誤觸動區域 An area to protect miss-input when top enclosure edge touches the touch panel.

5. 特性 Characteristics

5.1 光學特性 Optical characteristics

項 目 Item	規 格 Specification	備 註 Remarks
1 全光線透過率 TRANSPARENCY	80%Typ. (動作保證範圍內) (Inside of guaranteed active area)	JIS K-7105
2 HAZE	5.0% Typ.	JIS K-7105

5.2 環境特性 Environmental characteristics

項 目 Item	規 格 Specification	備 註 Remarks
1 動作溫度 Operation temperature	-10°C ~ 60°C	Max. wet Temp. is 38°C(No dew) 以上條件不代表環境測試規格
2 保存溫度 Storage temperature	-20°C ~ 70°C	
3 動作濕度 Operation Humidity	20% ~ 90%RH	
4 保存濕度 Storage temperature	10% ~ 90%RH	

原圖管理元  
↑  
日付

					Title: Touch Panel Spec.	
					Draw No. Tech Bes TTI-1 1002	
					Cust	
ED	Date	Design	Check	Description		
Des	20120704	Cloud	Chk		App.	
					富晶通科技股份有限公司 Transtouch Technology Inc.	
					SHEET	4/18

5.3 機械特性 Mechanical characteristics

項目 Item	規格 Specification	備註 Remarks
1 表面硬度 Hardness of surface	鉛筆硬度 3H Pencil hardness 3H.	JIS K-5600-5-4
2 FPC 剝離強度 FPC peeling strength	5N 以上 5N Min	向上垂直剝離 Peeling upward by 90°
3 FPC 彎曲 Bending	彎曲 3 回	R1.0mm 角度 90°
4 FPC 插拔	插拔 5 回	
5 最低入力荷重 Minimum input force	筆 Pen 指 Finger Max: 50gf	動作保證範圍內 2mm,但不分布在邊緣及 Dot-Spacer 之上 測定條件請參照註 1 Within 2mm of "guaranteed active area", but not on the edge and Dot-Spacer. Refer Note-1

5.4 電氣特性 Electrical characteristics

項目 Item	規格 Specification	備註 Remarks
1 額定電壓 Rated Voltage	DC 7V Max.	
2 電極間電阻 Resistance	X axis : 400Ω ~ 1300Ω(Film 側)	FPC 連接端測量 At connector
	Y axis : 60Ω ~ 700Ω(Glass 側)	
3 直線性 Linearity	±1.5%以下「最初值」 max 「initial value」 ±3.0%以下「環境及壽命試驗後」 max 「after environmental & life test」	測定條件請參照註 2 Refer Note-2 測試力量: 250gf
4 絕緣電阻 Insulation Resistance	20MΩ 以上(DC 25V) 20MΩ Min(DC 25V)	

原圖管理元

↑

日付

Title: Touch Panel Spec.

Draw No. Tech Bes TTI-11002

Cust

ED	Date	Design	Check	Description	
Des	20120704	Cloud	Chk	App.	

富晶通科技股份有限公司  
Transtouch Technology Inc.

SHEET

5/18

註 1: Note-1

最低入力荷重測定條件

Measurement condition of minimum input force

按下 film 表面，X 軸 Y 軸間的電阻值在 2kΩ 以下時所測得的最低入力荷重。

Resistance between X & Y axis must be equal or lower than 2kΩ ( $R_{on} \leq 2k\Omega$ ).

註 2: Note-2

直線性測定條件

Measurement condition of Linearity

在動作保證範圍內 1mm，沿著 X、Y 各軸的直線上任意複數點

將最外端的點連結成一假想直線，相對於此線的偏差值。

直線性是基準電壓分割值得最大偏差電壓。

Difference between actual voltage & Theoretical voltage is an error at any points.

Linearity is the value max. error voltage divided by voltage difference on active area within 1mm.

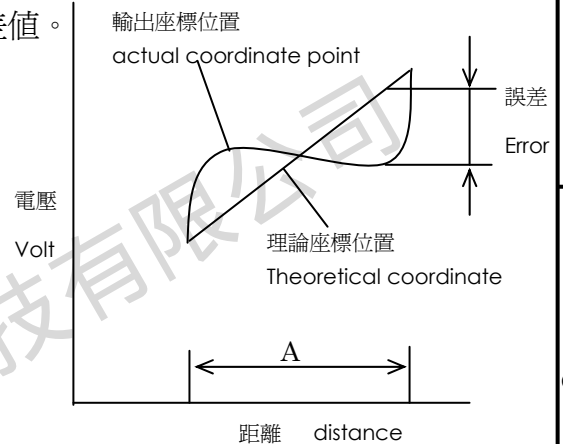

A: 動作保證範圍  
Guaranteed active area

6. 耐久性 life test condition

6.1 機械特性 Mechanical characteristics

1	筆寫壽命 Notes life	10 萬字以上 10 <sup>5</sup> words min	動作保證範圍內 Within "guaranteed active area"
2	打點壽命 Input life	100 萬次以上 10 <sup>6</sup> times min	動作保證範圍內 Within "guaranteed active area"

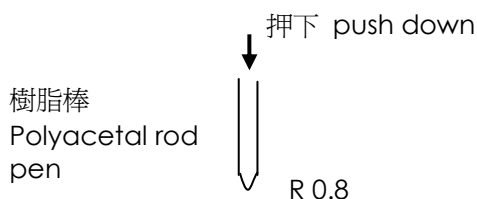

Fig.1 筆輸入 by pen

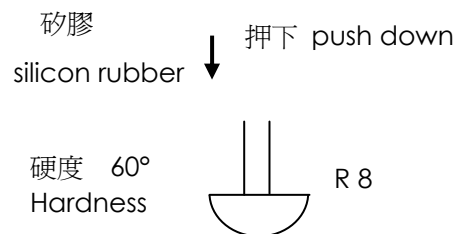

Fig.2 指輸入 by finger

Title: Touch Panel Spec.

Draw No. Tech Bes TTI-11002

Cust

ED	Date	Design	Check	Description	富晶通科技股份有限公司 Transtouch Technology Inc.	SHEET 6/18
Des	20120704	Cloud	Chk	App.		

原圖管理元

日付

A

B

C

D

A

B

C

D

E

F

※ 筆寫壽命(耐久性)試驗條件 Notes life test condition (by pen)

在動作保證範圍內以任意 A.B.C...7.5 ×6.75mm 大小的文字在 10 ×9mm 大小區域中，以下記的筆連續書寫。

Notes area for pen notes life test is 10×9mm. Size of word is 7.5×6.75mm. Word is any A.B.C..... word. Center of each word is changed at random in notes area.

- 筆尖端 Shape of pen end : R 0.8 (Refer Fig.1)
- 筆材料 Materials of pen : Polyacetal
- 入力荷重 Load : 250g
- 速度 Speed : 60mm/s

【 判定基準 Judge base 】

關於入力荷重、絕緣電阻、電極間電阻需滿足 5.3,5.4 的特性

Operation force, Insulation resistance & Resistance stated before as 5.3 , 5.4 must be within spec.

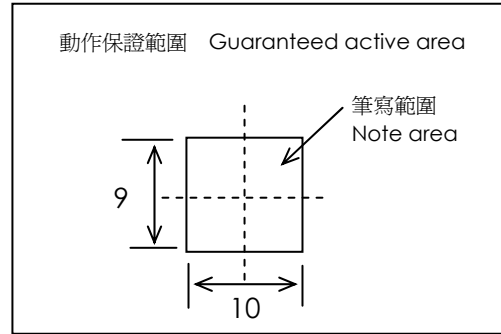

※ 打點壽命(耐久性)試驗條件 Input life test condition( by finger )

使用矽膠在同一地方連續打點

By silicone rubber tapping at same point.

- 橡膠尖端 Sharp of rubber end : R8 硬度 Hardness 60°(Refer fig.2)
- 操作力 Load : 200g
- 操作頻率 Frequency : 5Hz

【 判定基準 Judge base 】

關於入力荷重、絕緣電阻、電極間電阻需滿足 5.3 , 5.4 的特性

Operation force , Insulation resistance & Resistance stated before as 5.3,5.4 must be within spec.

原圖管理元	↑
	日付

					Title: Touch Panel Spec.	
					Draw No. Tech Bes TTI-11002	
					Cust	
ED	Date	Design	Check	Description		
Des	20120704	Cloud	Chk		App.	
					富晶通科技股份有限公司 Transtouch Technology Inc.	
					SHEET	7/18

1 2 3 4

6.2 環境測試條件 Environmental test condition

項目 Item	規格 Specification	備註 Remarks
1 高溫保存試驗 High temperature storage	70°C, 240 hr (After 24 hr room temp. and test)	關於最低入力荷重、絕緣電阻、電極間電阻需滿足 5.3, 5.4 的特性 Minimum input force, Insulation resistance & Resistance stated before as 5.3, 5.4 must be within spec.
2 低溫保存試驗 Low temperature storage	-20°C, 240 hr (After 24 hr room temp. and test)	
3 高溫高濕保存試驗 High temperature high humidity storage	40°C, 95%RH, 240 hr (After 24 hr room temp. and test)	
4 溫度衝擊循環試驗 Temperature Cycling	-20°C ~ +70°C (0.5hr each), 50cycles	

7. 外觀規格 Appearance.

7.1 外觀基準適用領域(範圍) Scope of reject criteria.

誤輸入防止區域境界  
Touch Undetected Area

觸控面板  
Touch Panel

透明/不透明區域境界  
View Area

0.5mm

0.5mm

0.5mm

0.5mm

A

B

領域 Area	外觀仕様 Specification
A	使用上不會有可視的缺失而影響正常操作。檢查基準依據 7-2 項。 Without any defect point to effect on normal operation.
B	不檢查 None-specify.

A : 上蓋位置的內側區域  
Inside of Boundary Line of Top Enclosure.

B : 領域 A 以外 Without A area.

C : Beside View Area : no inspection

原圖管理元

日付

					Title: Touch Panel Spec.	
					Draw No. Tech Bes TTI-11002	
					Cust	
ED	Date	Design	Check	Description		
Des	20120704	Cloud	Chk	App.		
富晶通科技股份有限公司 Transtouch Technology Inc.					SHEET	8/18

原稿保存於商品技術至少 13 年

TTIR0670304



### 7.2 檢查環境(Check environment):

- a.檢查時間(Check time):15 秒內(In 15 Seconds)
- b.燈光照度(Lamp illumination) :700~1000Lux
- c.檢查距離(Check distance):眼睛距 Touch Panel 約 20~30cm(From touch panel 20~30cm)

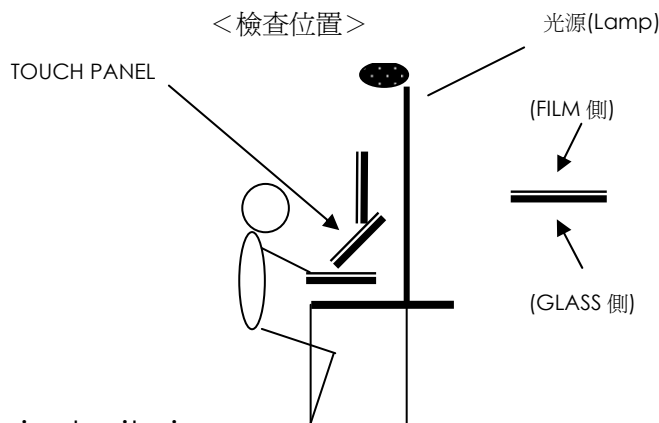

### 7.3 檢查基準 Reject criteria.

項 目 Description	檢 查 基 準 Reject criteria
Film / 玻璃刮傷 Film / Glass Scratch	0.3mm < D : zero
Film /玻璃間 異物/髒污 Foreign material between glass & film	0.1mm < D ≤ 0.3mm : Max: 2 points D ≤ 0.1mm : disregard
Film 打痕(魚眼) Film fish eye	0.25mm < D : zero D ≤ 0.25mm : Max: 2 points
Film / 玻璃表面線狀刮傷 Film / Glass Scratch (Line type)	0.05mm < W : zero
FILM / 玻璃間線狀異物 Foreign material between glass & film(Line type)	0.025mm < W ≤ 0.05mm : Max: 2 points & L ≤ 5mm W ≤ 0.02 : disregard
全部缺陷數 Total Defects	4 points Max.
缺陷間最小距離 Minimum distances between defects	1mm Min.
牛頓環, Newton ring	Film 面無牛頓環，但是在同一條件之下從玻璃面所見的牛頓環不在規範內。 Not seen from PANEL film side under fluorescent lamp, exclude from PANEL glass side .

※ D : Diameter[D=(長徑+短徑)/2], W : 寬(Width), L : 長(Length)

原圖管理元

↑

日付

					Title: Touch Panel Spec.	
					Draw No. Tech Bes TTI-11002	Cust
ED	Date	Design	Check	Description		富晶通科技股份有限公司
Des	20120704	Cloud	Chk	App.		Transtouch Technology Inc.
						SHEET 9/18

※線狀:以實際線最大寬線為 W ,最長外圍為 L

※魚眼圓點 (Fish Eye) :

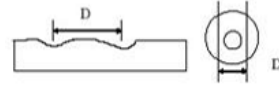
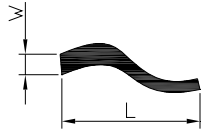

※覆判時以如下備註判定:

When a defect is difficult to judge , it will be judged as following:

(1) 缺陷型式:

Defect type:

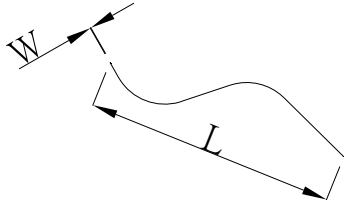

線狀缺陷

W:異物本體最大寬度

L:頭尾直線距離

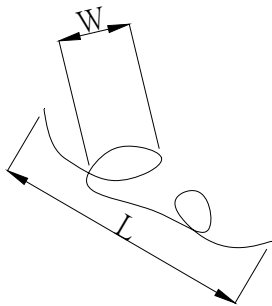

線狀缺陷

W:最大環形直徑

L:頭尾直線距離

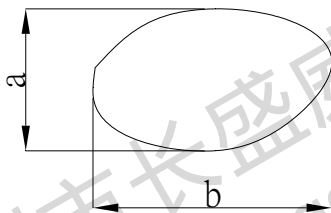

點狀缺陷

$D=(a+b)/2$

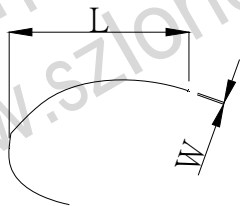

線狀異物(未滿半圓)

W:異物本體最大寬度

L:異物最長直線距離

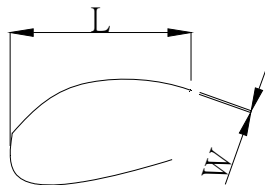

線狀異物(過半圓)

W:異物本體最大寬度

L:異物最長直線距離

原圖管理元  
↑  
日付

					Title: Touch Panel Spec.	
					Draw No. Tech Bes TTI-1 1002	Cust
ED	Date	Design	Check	Description		富晶通科技股份有限公司 Transtouch Technology Inc.
Des	20120704	Cloud	Chk	App.		
					SHEET	10/18

A

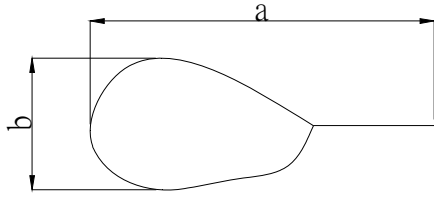

點狀異物  
 $D=(a+b)/2$

B

(2)  $0.3\text{mm} < D$  以線狀缺陷判定

$0.3\text{mm} < D$  as linear defect.

(3) 遇密集多點缺陷時判斷準則:各點的間距  $< 0.1\text{mm}$  , 則視為一點缺陷; 若各點間距  $\geq 0.1\text{mm}$  , 則視為多點缺陷

In high density defect situation, the distance between each other of the defects  $< 0.1\text{mm}$  is just as one point-defect,  $\geq 0.1\text{mm}$  is just as many point-defects .

※ TP 表面異物、髒污可用氣槍清除者不計

Foreign objects/dirt/scratches can be cleared by air gun that is allowed.

※ 保護膜及背膠離型紙外觀不計

Protective sheet and protective sheet of rear DSA can't be checked that is allowed.

※ Panel 不做透光檢

Panel can't be checked in front of the lamp.

C

※ 一般外觀檢驗仍以目視檢驗為主,但當有些缺陷並不能用肉眼去辨識他的時候, 建議使用 10 倍放大鏡輔助確認

Any defect is always checked by naked eye. When the defect can not be judged with naked eye. Please use ocular(x10) to check the defect.

D

原圖管理元	↑
日付	

					Title: Touch Panel Spec.	
					Draw No. Tech Bes TTI-11002	Cust
ED	Date	Design	Check	Description		富晶通科技股份有限公司
Des	20120704	Cloud	Chk	App.		Transtouch Technology Inc.
					SHEET	11/18

A

B

C

D

A

B

C

D

E

F

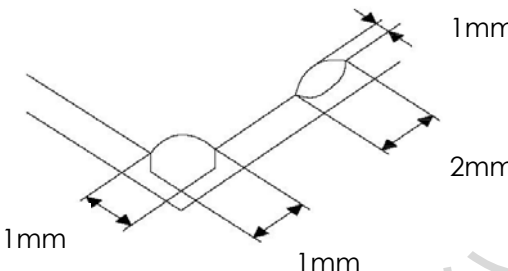
項 目 Description	檢 查 基 準 Reject criteria
玻璃瑕疵 Glass flaw	不超過下述的規範值，數量不限。 厚度方向的瑕疵(缺角)最大到板厚為止。 To be no flaw which size is over the drawing Specified as blow. Number of flaw is none-specify. Traveling flaw is none. Flaw of thickness direction size is max. 
Film 外形大小 Film size	Film 的大小不超出玻璃外形 ( 雙面膠也不可超出外型 )。 Film is in glass area (or size). (Exclude double-side adhesive tape)
FPC 異物/髒污 Foreign material for FPC	Cover Film 內層雜質不可跨越兩迴路。 Foreign material can not short two patterns.
FPC 刮傷 FPC Scratch	會造成製品電氣特性障礙的刮傷皆不可。 Any caused scratch which effects electrical characteristics is prohibited
FPC 皺折 FPC Crumple	會造成製品電氣特性障礙的皺折皆不可。 Any caused crumple which effects electrical characteristics is prohibited

8. 表示方法 Showing

Touch Panel 製造型格及製造年月份表示方法。

Showing to P/No., Production & Year/Month.

	表 示 Showing	意 思 Meaning	備 考 Notes
製品型格 Product No.	1301-962	T010 - 1301 - T962	
製造批號 Production Lot No.	雷射打印於 Film 面 12010001	前兩碼(1, 2 碼)為年份(11: 2012 年); 年份後兩碼(3, 4 碼)為月份(01: 1 月); 其他碼(5~8 碼)為流水號	製造批號 Production Lot No.

原圖管理元 ↑

日付

				Title: Touch Panel Spec.	
				Draw No. Tech Bes TTI-11002	
				Cust	
ED	Date	Design	Check	Description	
Des	20120704	Cloud	Chk	App.	
				富晶通科技股份有限公司 Transtouch Technology Inc.	
				SHEET	12/18

9. 注意事項 Attention

(1) 本產品是使用玻璃所製，因為玻璃的邊、角是銳利的，在使用觸控面板時請多注意。  
在使用觸控面版時請戴手套作業。

Since Touch Panel is consist of glass, please be careful your hands to be injured during handling. You must wear gloves during handling.

(2) 本產品是使用玻璃所製，在使用觸控面板時，請注意不要施加強力衝擊。

Do not strike touch panel.

(3) 拿起觸控面板時請勿從 FPC 拿取。

Do not lift touch panel by cable (FPC).

(4) 在 FILM 面處請勿施加重力。(例: 在組裝時從 FILM 吸取移動)

Excessive force onto the film surface is prohibited.

(Ex. Don't transfer the panel from film surface with vacuum)

(5) 表面清潔時，請使用「乾的柔性布」或「浸泡過中性清潔液擰乾的布」或「沾有酒精的柔性布」。請勿使用有機溶劑、酸、鹼類溶劑。

Please use dry cloth or soft cloth with neutral detergent (after wring dry) or one with ethanol at cleaning. Do not use any organic solvent, acid or alkali solution.

(6) 保存時請勿重疊放置。特別是請勿用重物壓著。

Do not stack the touch panels together. Do not put heavy objects on touch panels.

(7) FPC 請勿折彎，有可能使迴路線斷裂。特別是對於連結器的插入部分，因為貼有補強板，在插入連結器時請勿施加過多的力量。請避免以下圖方式插入。

Do not bend the cable (FPC) of touch panel to prevent the circuit broken.

Please don't use following method to insert the FPC tail to connector.

原圖管理元  
↑  
日付

					Title: Touch Panel Spec.	
					Draw No. Tech Bes TTI-11002	Cust
ED	Date	Design	Check	Description		富晶通科技股份有限公司 Transtouch Technology Inc.
Des	20120704	Cloud	Chk		App.	13/18

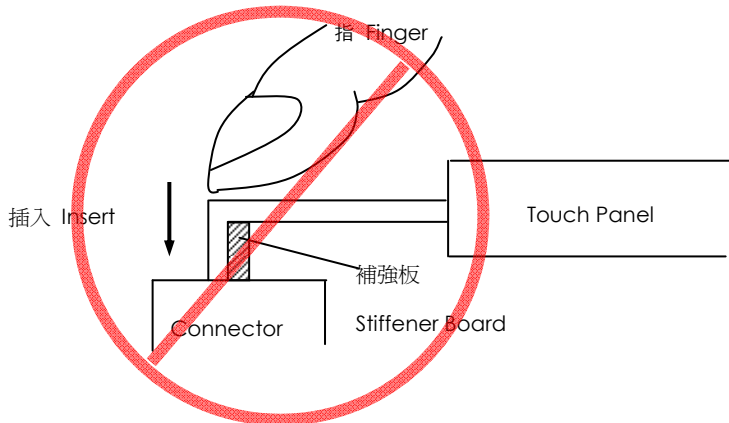

(8) 在實際組裝設計時，請注意以下事項。

Please pay attention for the matters stated below at mounting design of touch panel & enclosure

-1. 觸控面板的上蓋支撐物請設定在透明範圍的外側。  
 (上蓋請勿壓在透明範圍上，會有誤動作的情況發生)  
 Enclosure support to fix touch panel must be out of view (transparent) area. (Do not design enclosure presses the view area to protect from miss input)

-2. 上蓋的外框請設定在透明範圍的內側、動作保證範圍的外側。  
 (上蓋的外框請勿接觸到透明範圍)。  
 The enclosure edge must be between view area & Guaranteed active area. (Enclosure edge must not touch the view area)

-3. 觸控面板上下部的壓合，請以橡膠等彈性材質。  
 Elastic materials are recommended as a support to fix touch panel.

-4. 使用時，觸控面板的上面(FILM)請勿與上蓋黏著固定。  
 Do not use an adhesive tape to bond the top surface (film side) of touch panel with enclosure.

-5. 觸控面板上部的邊角，因為玻璃導電層有傳導性，在組裝設計時請注意不要與金屬材質接觸。  
 The corners and edges of touch panel (fig.\*) may be conductive. Do not touch it with metallic components after mounting.

原圖管理元  
↑  
日付

					Title: Touch Panel Spec.	
					Draw No. Tech Bes TTI-11002	
					Cust	
ED	Date	Design	Check	Description		
Des	20120704	Cloud	Chk		App.	
					富晶通科技股份有限公司 Transtouch Technology Inc.	
					SHEET	14/18

-6. 有防水需求時，請考慮用橡膠等材質對迴路週邊做防水。

Special design is required for water resistance.

-7. 當使用 Air gun 向觸控面板吹氣時，建議 Air 壓力調整為 2kg/cm<sup>2</sup> 以下，並且勿從玻璃側朝 FPC 直接吹氣，以免 FPC 在強烈 Air 壓力下，造成脫落。

Cleaning touch panel by Air gun, pressure below 2kg/cm<sup>2</sup> is suggested. To prevent FPC to be peeled off, air blowing to the FPC is avoided from glass side.

【實裝構造例 Mounting condition example 1】

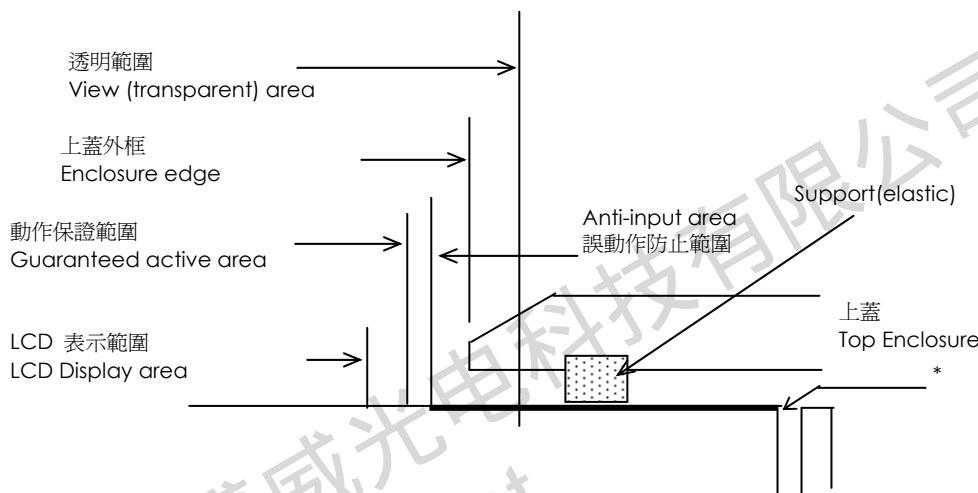

-8. 必須在靠近 FPC 位置處預留 FPC 線路空間，絕對避免外殼或其他零件碰觸或擠壓 FPC，造成 FPC 脫落。

The mounting structure must has a reserved space for the FPC tail and never touch or squeeze the FPC by case or another components preventing FPC to peel off.

原圖管理元  
↑  
日付

					Title: Touch Panel Spec.	
					Draw No. Tech Bes TTI-11002	
					Cust	
ED	Date	Design	Check	Description		
Des	20120704	Cloud	Chk		App.	
					富晶通科技股份有限公司 Transtouch Technology Inc.	
					SHEET	15/18

【實裝構造例 Mounting condition example 2】

A

A

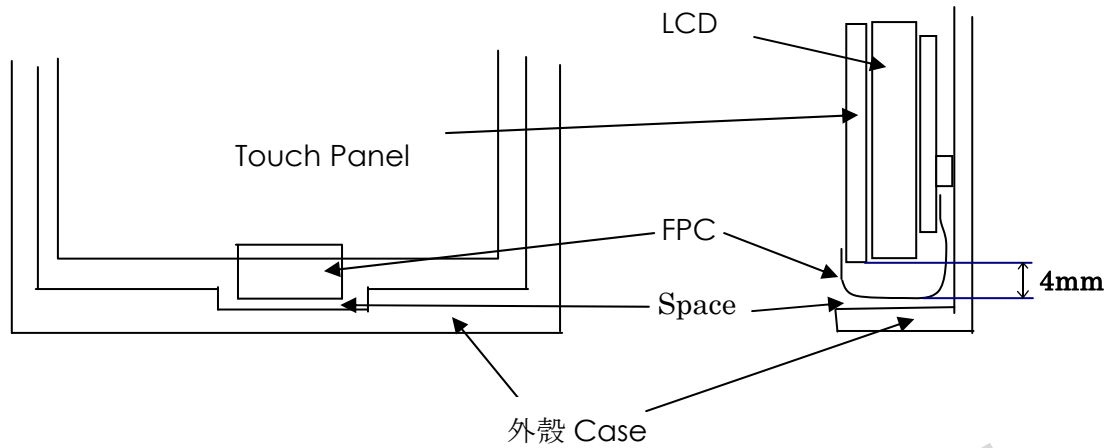

B

B

【實裝構造例 Mounting condition example 3】

C

C

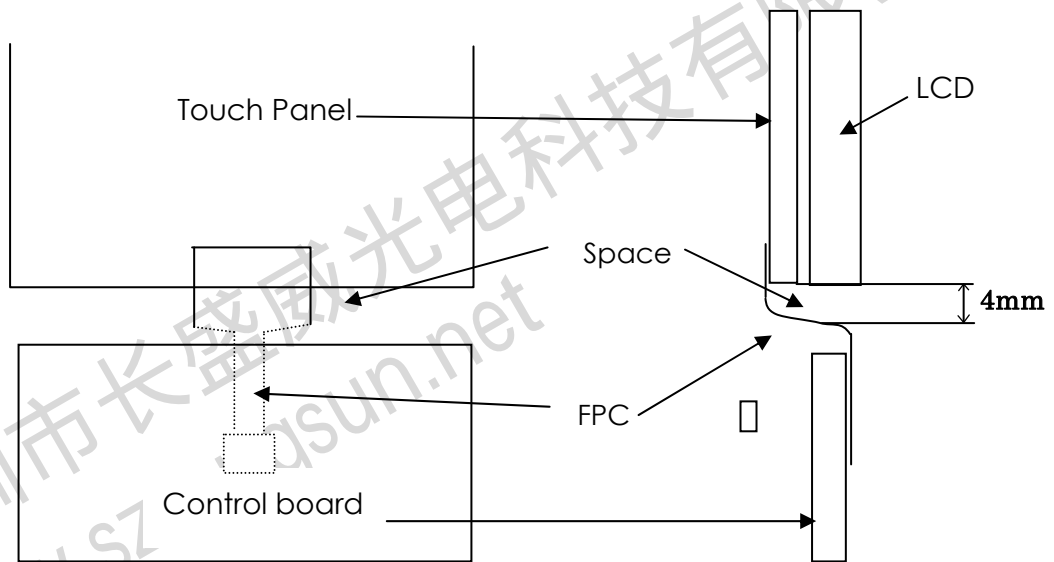

D

D

-9.Touch Panel 本體一般保固一年,如有客戶特殊需求者依雙方另外制定標準。

Touch Panel has a year's guarantee. If the customer have special request, we can make a contract for it.

-10.VA 區及誤輸入防止區的界線上禁止外力擠壓與操作書寫,避免 ITO Crack 導致線性偏移。

Avoid operating or writing on VA/Anti-Input Area ,to prevent ITO cracking. That will make a Linearity NG.

原圖管理元  
↑  
日付

					Title: Touch Panel Spec.	
					Draw No. Tech Bes TTI-11002	Cust
ED	Date	Design	Check	Description		富晶通科技股份有限公司 Transtouch Technology Inc.
Des	20120704	Cloud	Chk	App.		
					SHEET	16/18



1 2 3 4

10. 包裝型式 Packing Method :

如圖 as drawing

A  
B  
C  
D

製品 (Film 面貼附保護膜)

Product (protect sheet added)

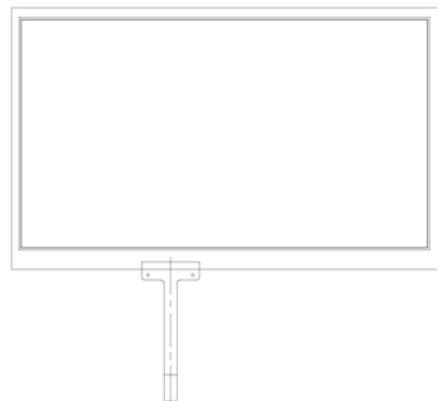
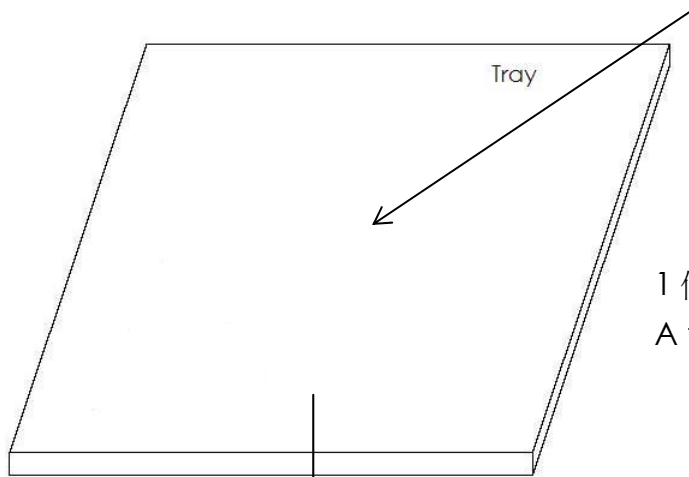
Tray

1 個 Tray 盤可裝 4 片觸控面板

A tray with 4 pieces of touch panels

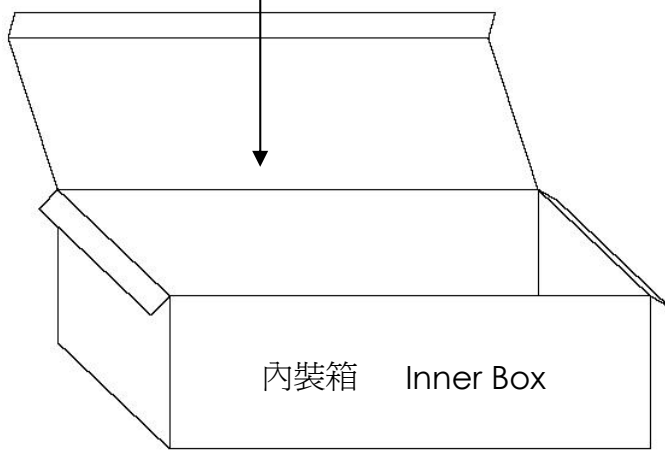

內裝箱 Inner Box

16 個 Tray 盤裝入一個內裝箱  
16 pieces of trays packaged  
and then an inner box

2 Inner Box and Cushion    ↓ 內裝箱 2 個 + 緩衝材

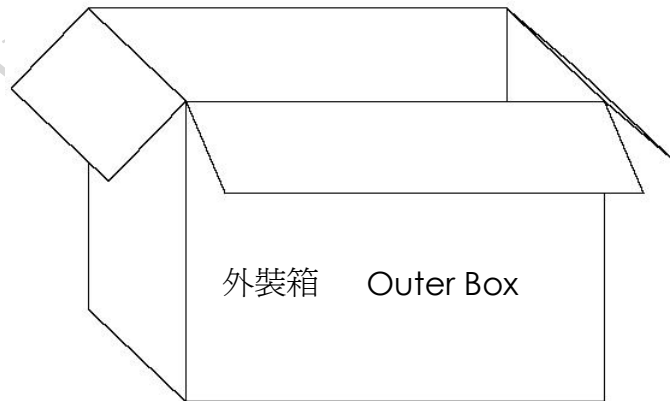

外裝箱 Outer Box

1 個裝滿的外裝箱內含 120 片觸控面板  
A full outer box with 120 pieces of  
touch panels

原圖管理元  
↑  
日付

					Title: Touch Panel Spec.	
					Draw No. Tech Bes TTI-11002	
					Cust	
ED	Date	Design	Check	Description		
Des	20120704	Cloud	Chk		App.	
					富晶通科技股份有限公司 Transtouch Technology Inc.	
					SHEET	17/18

原稿保存於商品技術至少 13 年

TTIR0670304

包裝箱外側兩邊以圖章打印綠色『RoHS』字樣

Two green RoHS marks stamped on both sides of one full carton

A

A

RoHS

B

B

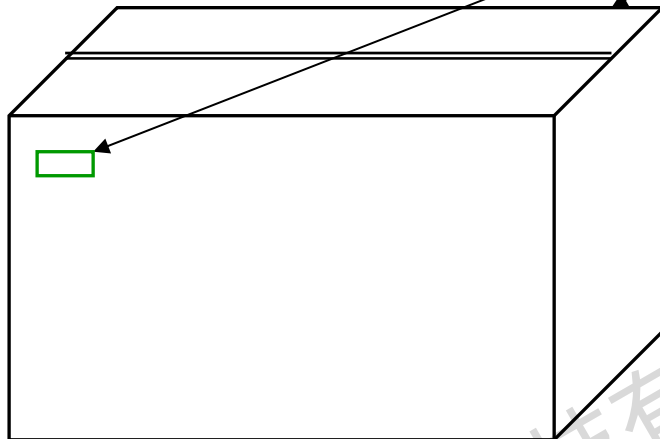

C

C

D

D

深圳市长盛威光电科技有限公司  
www.szlongsun.net

原圖管理元  
↑  
日付

					Title: Touch Panel Spec.	
					Draw No. Tech Bes TTI-11002	
					Cust	
ED	Date	Design	Check	Description		
Des	20120704	Cloud	Chk		App.	
					富晶通科技股份有限公司 Transtouch Technology Inc.	
					SHEET	18/18

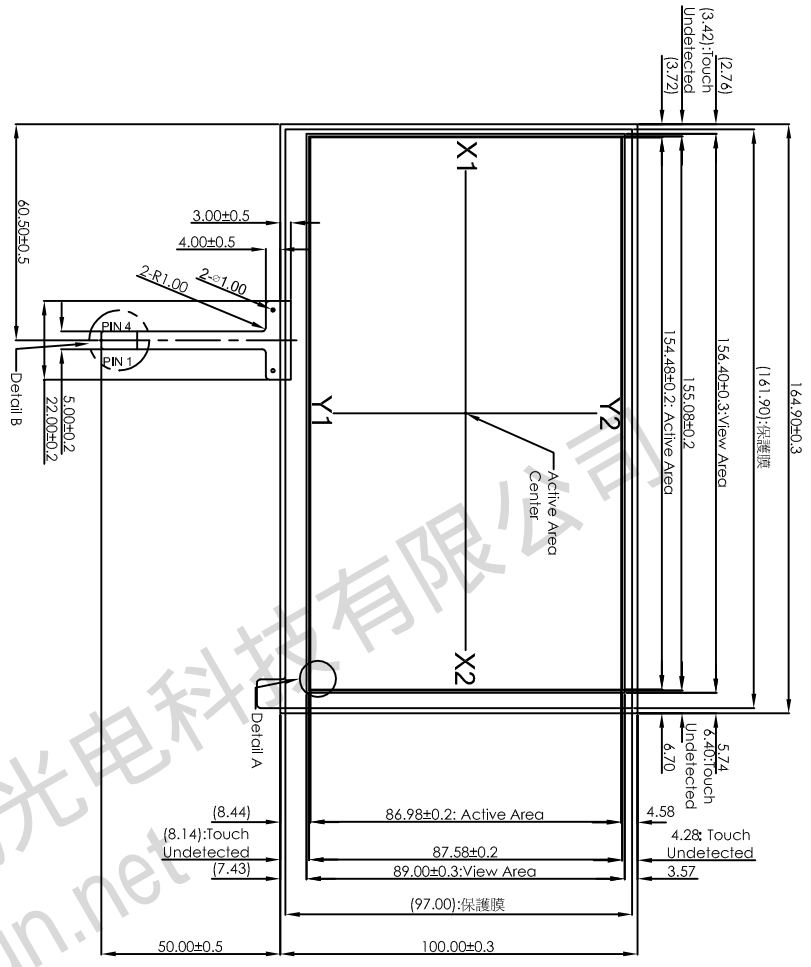

- Note:
1. Tolerance : ±0.5
  2. Pen & Finger Input Type
  3. Surface Hardness: 3H
  4. Transmittance: 80% Typ. (JIS-K7105)
  5. Film: Anti-glare

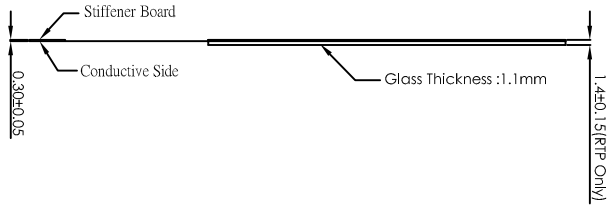
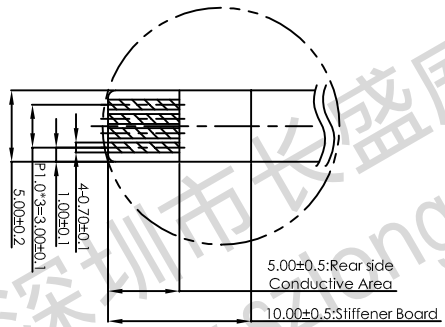

Connector Pin Assignment

Pin No.	Description
1	Y2
2	X2
3	Y1
4	X1

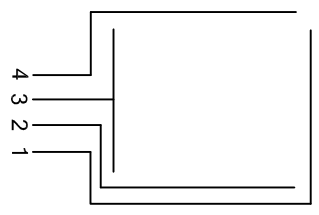

圖號	TOUCH PANEL	比例	1:1
圖名	Tech Bes TI-11002	圖出處	
製圖		審核	
設計		單位	
日期	2011.01.12	Version	1.00
製圖		製圖	
設計		審核	
製圖		單位	
製圖		製圖	

富晶通科技股份有限公司 | 頁 1/1