

PRODUCT SPECIFICATION

A

- 1. PRODUCT : TOUCH PANEL
- 2. PART NUMBER : TTI : T010-1301-T903
- 3. ATTACHED DRAWING : Tech Bes TTI-13031

B

SIGNATURE FOR YOUR RECEIPT

DATE:

C

TRANSTOUCH TECHNOLOGY INC. (TTI)
 DOCUMENT No. : TTI PRODUCT TECHNOLOGY Dept.

D

MANAGER : _____ DATE: _____

TTI PRODUCT TECHNOLOGY Dept.
 6F No.50 Hwa-Ya 3rd Road ,Kwei-san Shian Tao-yuan ,Taiwan
 TEL(03)3978800 FAX(03)3978855

PROPRIETARY NOTE
 This document contains information confidential and proprietary to TRANSTOUCH TECHNOLOGY INC. (TTI) and shall not be reproduced or transferred to other documents or disclosed to other or used for any purpose other than for which it was obtained without the expressed written consent of TRANSTOUCH TECHNOLOGY INC. (TTI)

原圖管理元

↑

日付

					Title: Touch Panel Spec.	
					Draw No. Tech Bes TTI-13031	Cust
ED	Date	Design	Check	Description		富晶通科技股份有限公司 Transtouch Technology Inc.
Des	20140408	Cloud	Chk	App.		
					SHEET	1/19

F

觸控面板製品規格書
TOUCH PANEL SPECIFICATION

富晶通科技股份有限公司
TRANSTOUCH TECHNOLOGY INC.

深圳市长盛威光电技术有限公司
www.szlongsun.net

原圖管理元	↑
日付	

					Title: Touch Panel Spec.	
					Draw No. Tech Bes TTI-13031	
					Cust	
ED	Date	Design	Check	Description		
Des	20140408	Cloud	Chk		App.	
					富晶通科技股份有限公司 Transtouch Technology Inc.	
					SHEET	2/19

觸控面板製品規格書
TOUCH PANEL SPECIFICATION

A

1. 適用範圍 Application

此規格書是適用富晶通科技股份有限公司所製作的觸控面板。
This specification is applied to TOUCH PANEL made by
TRANSTOUCH TECHNOLOGY INC. (TTI)。

【製品圖號 Product No.】

品名 Name	製品圖號 P/No.	尺寸 Size	備註 Remark
觸控面板 TOUCH PANEL	T010-1301-T903	7"	筆/指輸入兼用 for pen & finger input (RoHS)

B

2. 概要 Function

此製品是裝置在 LCD 等平面顯示器上使用電阻薄膜的觸控面板。以尖端為 R 0.8mm 的筆或是以手指按下觸控面板的表面，觸控面板的電壓會透過檢出迴路將座標值檢測出來。
TTI TOUCH PANEL is resistance type that customer uses with flat display as a LCD. Once user touches it by a resin PEN with round end or by FINGER directly, the circuit for TOUCH PANEL sends coordinate point to PC from voltage at contact point.

C

3. 製造者 Manufacturer

富晶通科技股份有限公司 TRANSTOUCH TECHNOLOGY INC. (TTI)

所在地:桃園縣龜山鄉(華亞科技園區)華亞三路 50 號 6 樓

Address:6F No.50 Hwa-Ya 3rd Road ,Kwei-san Shian Tao-yuan ,Taiwan

D

4. 外型 Outline

4.1 外型圖 Drawing

參考最後附加圖面

Please refer the last page of this spec.

D

原圖管理元



日付

					Title: Touch Panel Spec.	
					Draw No. Tech Bes TTI-13031	Cust
ED	Date	Design	Check	Description		富晶通科技股份有限公司 Transtouch Technology Inc.
Des	20140408	Cloud	Chk	App.		SHEET 3/19

F

4.2 用語定義 Definition of words

用 語 Words	定 義 Definition
動作保證範圍 Guaranteed active area	觸控面板的特性保證範圍。 An area to be guaranteed all characteristics stated on this spec.
上蓋邊界 Boundary line of top enclosure	表示上蓋外框的建議位置。 Recommended boundary line of top enclosure
透明範圍 View (transparent) area	雙面膠或是從電極內側的透明範圍。 A view area which is inside adhesive zone or electrode pattern. Top enclosure must not be fixed by this area.
誤輸入防止範圍 Touch undetected	在透明絕緣的範圍上，防止上蓋邊緣的誤觸動區域 An area to protect miss-input when top enclosure edge touches the touch panel.

5. 特性 Characteristics

5.1 光學特性 Optical characteristics

	項 目 Item	規 格 Specification	備 註 Remarks
1	全光線透過率 TRANSPARENCY	85+/-3%. (動作保證範圍內) (Inside of guaranteed active area)	JIS K-7105
2	HAZE	5+/-2%.	JIS K-7105

5.2 環境特性 Environmental characteristics

	項 目 Item	規 格 Specification	備 註 Remarks
1	動作溫度 Operation temperature	-30°C ~ 85°C	Max. wet Temp. is 38°C(No dew)
2	保存溫度 Storage temperature	-30°C ~ 85°C	以上條件不代表環境測試規格
3	動作濕度 Operation Humidity	20% ~ 90%RH	
4	保存濕度 Storage temperature	10% ~ 90%RH	

原圖管理元



日付

					Title: Touch Panel Spec.			
					Draw No. Tech Bes TTI-13031		Cust	
ED	Date	Design	Check	Description			富晶通科技股份有限公司	SHEET 4/19
Des	20140408	Cloud	Chk	App.			Transtouch Technology Inc.	

5.3 機械特性 Mechanical characteristics

項目 Item	規格 Specification	備註 Remarks
1 表面硬度 Hardness of surface	鉛筆硬度 3H Pencil hardness 3H.	JIS K-5600-5-4 150gf, 角度 45 度
2 FPC 剝離強度 FPC peeling strength	5N 以上 5N min	向上垂直剝離 Peeling upward by 90°
3 FPC 彎曲 Bending	彎曲 3 回	R1.0mm
4 FPC 插拔	插拔 5 回	
5 最低入力荷重 Minimum input force	筆 Pen 指 Finger Max: 80gf	動作保證範圍 5mm 內,但不分布在邊緣及 Dot-Spacer 之上 Within 5mm" guaranteed active area", but not on the edge and Dot-Spacer.

5.4 電氣特性 Electrical characteristics

項目 Item	規格 Specification	備註 Remarks
1 額定電壓 Rated Voltage	DC 7V max.	
2 電極間電阻 Resistance	X axis : 450Ω ~ 1200Ω (FILM 側) Y axis : 100Ω ~ 600Ω (GLASS 側)	FPC 連接端測量 At connector
3 直線性 Linearity	±1.5%以下「最初值」 max 「initial value」 ±3.0%以下「環境及壽命試驗後」 max 「after environmental & life test」	測定條件請參照註 1 Refer Note-1 測試力量: 250gf
4 絕緣電阻 Insulation Resistance	10MΩ 以上 (DC 25V) 10MΩ min (DC 25V)	

原圖管理元
↑
日付

					Title: Touch Panel Spec.	
					Draw No. Tech Bes TTI-13031	
					Cust	
ED	Date	Design	Check	Description		
Des	20140408	Cloud	Chk		App.	
					富晶通科技股份有限公司 Transtouch Technology Inc.	
					SHEET	5/19

註 1: Note-1

最低入力荷重測定條件

Measurement condition of minimum input force

按下 film 表面，X 軸 Y 軸間的電阻值在 2kΩ 以下時所測得的最低入力荷重。

Resistance between X & Y axis must be equal or lower than 2kΩ (Ron ≤ 2kΩ)。

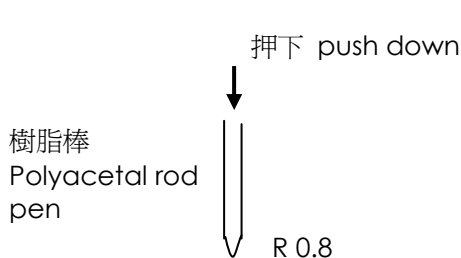

Fig.1 筆輸入 by pen

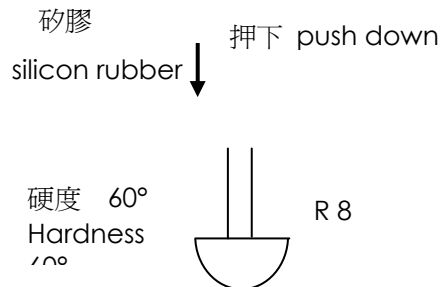

Fig.2 指輸入 by finger

註 2: Note-2

直線性測定條件

Measurement condition of Linearity

在動作保證範圍內 2mm，沿著 X、Y 各軸的直線上任意複數點將最外端的點連結成一假想直線，相對於此線的偏差值，直線性是基準電壓分割值得最大偏差電壓。

Difference between actual voltage & Theoretical voltage is an error at any points.

Linearity is the value max. error voltage divided by voltage difference on active area inside 2mm.

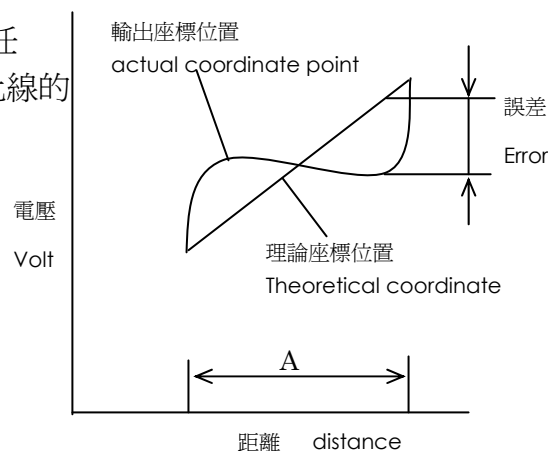

A: 動作保證範圍
Guaranteed active area

原圖管理元
↑
日付

					Title: Touch Panel Spec.	
					Draw No. Tech Bes TTI-13031	
					Cust	
ED	Date	Design	Check	Description		
Des	20140408	Cloud	Chk		App.	
					富晶通科技股份有限公司 Transtouch Technology Inc.	
					SHEET	6/19

6. 耐久性 life test condition

6.1 機械特性 Mechanical characteristics

A	1. 打點壽命 Input life	100 萬次以上 10 ⁶ times min	動作保證範圍中心處 Center of guaranteed active area.	A
---	-----------------------	---------------------------------------	--	---

※ 打點壽命(耐久性)試驗條件 Input life test condition(by finger)

使用矽膠在同一地方連續打點

By silicone rubber tapping at same point.

- 橡膠尖端 Sharp of rubber end : R8 硬度 Hardness 60°
- 操作力 Load : 250g
- 操作頻率 Frequency : 5Hz

【 判定基準 Judge base 】

關於最低入力荷重、絕緣電阻、電極間電阻需滿足 5.3 , 5.4 的特性

Minimum input force , Insulation resistance & Resistance stated before as 5.3,5.4 must be within spec

6.2 環境測試條件 Environmental test condition

	項 目 Item	規 格 Specification	備 註 Remarks
1	高溫保存試驗 High temperature storage	85°C, 240 hr (After 24 hr room temp. and test)	關於最低入力荷重、絕緣電阻、電極間電阻需滿足 5.3 , 5.4 的特性
2	低溫保存試驗 Low temperature storage	-30°C, 240 hr (After 24 hr room temp. and test)	Minimum input force, Insulation resistance &
3	高溫高濕保存試驗 High temperature high humidity storage	60°C, 90%RH, 240 hr (After 24 hr room temp. and test)	Resistance stated before as 5.3, 5.4 must be within spec.
4	溫度衝擊循環試驗 Temperature Cycling	-30°C ~ +85°C (0.5hr each), 50cycles	

原圖管理元
↑
日付

					Title: Touch Panel Spec.	
					Draw No. Tech Bes TTI-13031	
					Cust	
ED	Date	Design	Check	Description		
Des	20140408	Cloud	Chk	App.		
					富晶通科技股份有限公司 Transtouch Technology Inc.	
					SHEET	7/19

7. 外觀規格 Appearance.

7.1 外觀基準適用領域(範圍) Scope of reject criteria.

領域 Area	外觀仕様 Specification
A	使用上不會有可視的缺失而影響正常操作。檢查基準依據 7-2 項。 Without any defect point to effect on normal operation.
B	不檢查 None-specify.

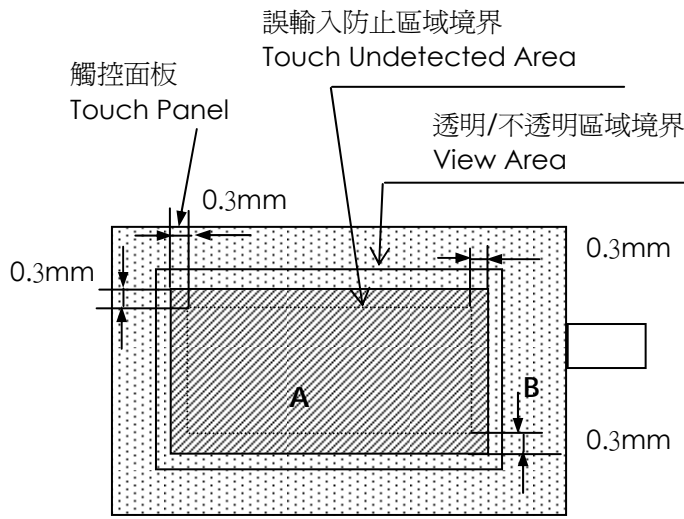

7.2 檢查環境(Check environment):

- a.檢查時間(Check time):15 秒內(In 15 Seconds)
- b.燈光照度(Lamp illumination) :700~1000Lux
- c.檢查距離(Check distance):眼睛距 Touch Panel 約 20~30cm(From touch panel 20~30cm)

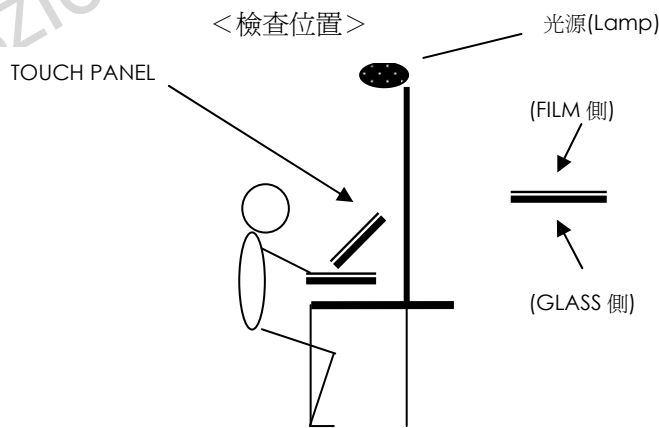

原圖管理元

日付

↑

					Title: Touch Panel Spec.	
					Draw No. Tech Bes TTI-13031	
					Cust	
ED	Date	Design	Check	Description		
Des	20140408	Cloud	Chk	App.	富晶通科技股份有限公司 Transtouch Technology Inc.	SHEET 8/19

7.3 檢查條件(Reject criteria):

項目 Description	檢查基準 Reject criteria
Film / 玻璃刮傷 Film / Glass Scratch	0.3mm<D : zero
Film /玻璃間 異物/髒污 Foreign material between glass & film	0.2mm<D≤0.3mm : Max: 5 points D≤0.2mm : disregard
Film / 玻璃表面線狀刮傷 Film / Glass Scratch (Line type)	0.1mm<W : zero
FILM / 玻璃間線狀異物 Foreign material between glass & film(Line type)	0.03mm<W≤0.1mm : Max: 5 points L≤10mm W≤0.03mm : disregard
牛頓環, Newton ring	無牛頓環/MORIE,在同一條件之下從玻璃面所見的牛頓環/MORIE 不在規範內。 Not seen from PANEL film side under fluorescent lamp, exclude from PANEL glass side.

※ D : Diameter [D=(長徑+短徑)/2], W : 寬(Width), L : 長(Length)

※線狀:以實際線最大寬線為 W ,最長外圍為 L

※魚眼圓點 (Fish Eye) :

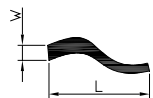

※覆判時以如下備註判定:

When a defect is difficult to judge , it will be judged as following:

(1) 缺陷型式:

Defect type:

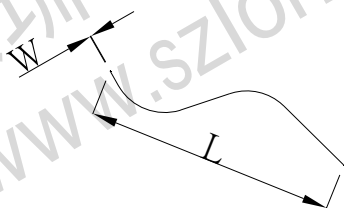

線狀缺陷

W:異物本體最大寬度

L:頭尾直線距離

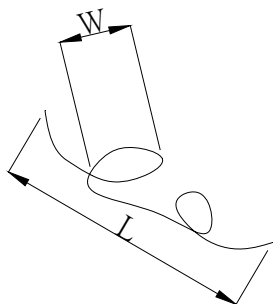

線狀缺陷

W:最大環形直徑

L:頭尾直線距離

原圖管理元
↑
日付

					Title: Touch Panel Spec.	
					Draw No. Tech Bes TTI-13031	
					Cust	
ED	Date	Design	Check	Description		富晶通科技股份有限公司
Des	20140408	Cloud	Chk	App.		Transtouch Technology Inc.
						SHEET
						9/19

A

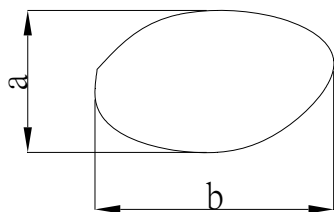

點狀缺陷
 $D=(a+b)/2$

B

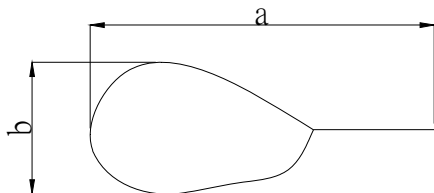

點狀缺陷
 $D=(a+b)/2$

C

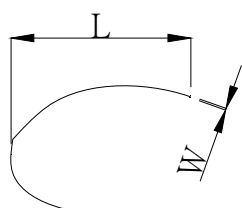

線狀缺陷(未滿半圓)
 W: 缺陷本體最大寬度
 L: 缺陷最長直線距離

D

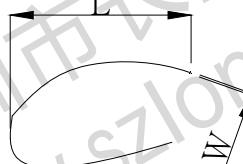

線狀缺陷(過半圓)
 W: 缺陷本體最大寬度
 L: 缺陷最長直線距離

(2) $0.3\text{mm} < D$ 以線狀缺陷判定

$0.3\text{mm} < D$ as linear defect.

(3) 遇密集多點缺陷時判斷準則:各點的間距 $< 0.1\text{mm}$, 則視為一點缺陷; 若各點間距 $\geq 0.1\text{mm}$, 則視為多點缺陷

In high density defect situation, the distance between each other of the defects $< 0.1\text{mm}$ is just as one point-defect, $\geq 0.1\text{mm}$ is just as many point-defects .

元 管理 圖 原

日 付

					Title: Touch Panel Spec.	
					Draw No. Tech Bes TTI-13031	
					Cust	
ED	Date	Design	Check	Description		
Des	20140408	Cloud	Chk		App.	
					富晶通科技股份有限公司	
					Transtouch Technology Inc.	
					SHEET	10/19

※ TP 表面異物、髒污可用氣槍清除者不計

Foreign objects/dirt/scratches can be cleared by air gun that is allowed.

A

※ 保護膜及背膠離型紙外觀不計

Protective sheet and protective sheet of rear DSA can't be checked that is allowed.

A

※Panel 不做透光檢

Panel can't be checked in front of the lamp.

※一般外觀檢驗仍以目視檢驗為主,但當有些缺陷並不能用肉眼去辨識他的時候,建議使用 10 倍以上放大鏡輔助確認

Any defect is always checked by naked eye. When the defect can't be judged with naked eye. Please use ocular(x10 min.) to check the defect.

B

B

C

C

D

D

E

F

深圳市长盛威光电科技有限公司
www.szlongsun.net

原圖管理元	↑
日付	

					Title: Touch Panel Spec.	
					Draw No. Tech Bes TTI-13031	
					Cust	
ED	Date	Design	Check	Description		
Des	20140408	Cloud	Chk		App.	
					富晶通科技股份有限公司 Transtouch Technology Inc.	
					SHEET	11/19

A

B

C

D

A

B

C

D

E

F

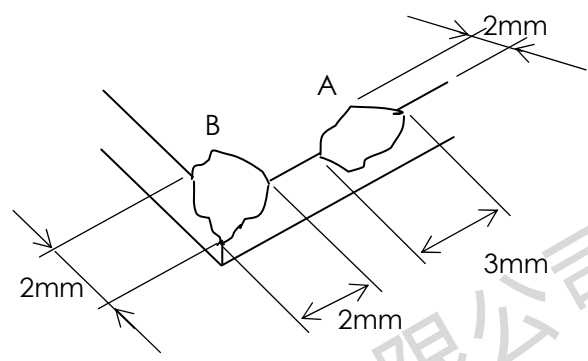
項 目 Description	檢 查 基 準 Reject criteria
玻璃瑕疵 Glass flaw	<p>不超過下述的規範值，數量不限。 厚度方向的瑕疵(缺角)最大到板厚為止。 To be no flaw which size is over the drawing Specified as below. Number of flaw is none-specify. Traveling flaw is none. Flaw of thickness direction size is max.</p> 
Film 外形大小 Film size	Film 的大小不超出玻璃外形。 Film is in glass area (or size).
FPC 異物/髒污 Foreign material for FPC	Cover Film 內層雜質不可跨越兩迴路。 Foreign material can not short two patterns.
FPC 刮傷 FPC Scratch	會造成製品電氣特性障礙的刮傷皆不可。 Any caused scratch which effects electrical characteristics is prohibited
FPC 皺折 FPC Crumple	會造成製品電氣特性障礙的皺折皆不可。 Any caused crumple which effects electrical characteristics is prohibited

原圖管理元

↑

日付

					Title: Touch Panel Spec.	
					Draw No. Tech Bes TTI-13031	
					Cust	
ED	Date	Design	Check	Description		富晶通科技股份有限公司 Transtouch Technology Inc.
Des	20140408	Cloud	Chk	App.		
					SHEET	12/19

8. 表示方法 Showing

Touch Panel 製造型格及製造年月份表示方法。

Showing to P/No., Production & Year/Month.

A

	表 示 Showing	意 思 Meaning	備 考 Notes
製品型格 Product No.	1301-903	T010 - 1301 - T903	
製造批號 Production Lot No.	雷射打印於 Film 面 13080001	前兩碼(1, 2 碼)為年份(13: 2013 年); 年份後兩碼(3, 4 碼)為月份 (08: 8 月); 其他碼(5~8 碼)為流水號	製造批號 Production Lot No.

B

- (1) 本產品是使用玻璃所製，因為玻璃的邊、角是銳利的，在使用觸控面板時請多注意。
在使用觸控面版時請戴手套作業。

Since touch panel is consist of Glass, pls. be careful your hand and other part from injury at handling. You must wear gloves at handling.

C

- (2) 本產品是使用玻璃所製，在使用觸控面板時，請注意不要施加強力衝擊。

Do not put a heavy shock or stress on touch panel.

- (3) 拿起觸控面板時請勿從 FPC 拿取。

Do not lift Touch Panel by cable (FPC).

D

- (4) 在 FILM 面處請勿施加重力。(例: 在組裝時從 FILM 吸取移動)

Do not add any stress only film face.

(Ex. Don't transfer the panel by film face with vacuum)

- (5) 表面清潔時，請使用「乾的柔性布」或「浸泡過中性清潔液擰乾的布」或「沾有酒精的柔性布」。請勿使用有機溶劑、酸、鹼類溶劑。

Pls. use dry cloth or soft cloth with neutral detergent (after wring dry) or one with ethanol at cleaning. Do not use any organic solvent, acid or alkali solution.

原圖管理元
↑
日付

					Title: Touch Panel Spec.	
					Draw No. Tech Bes TTI-13031	Cust
ED	Date	Design	Check	Description		富晶通科技股份有限公司 Transtouch Technology Inc.
Des	20140408	Cloud	Chk	App.	SHEET	13/19

(6) 保存時請勿重疊放置。特別是請勿用重物壓著。

Do not pile Touch Panel. Do not put heavy goods on Touch Panel.

(7) FPC 請勿折彎，有可能使迴路線斷裂。特別是對於連結器的插入部分，因為貼有補強板，在插入連結器時請勿施加過多的力量。請避免以下圖方式插入。

Do not bend a cable of Touch Panel for prevent happen to line cut failure. Please don't use following method for inserting into FPC tail to connector.

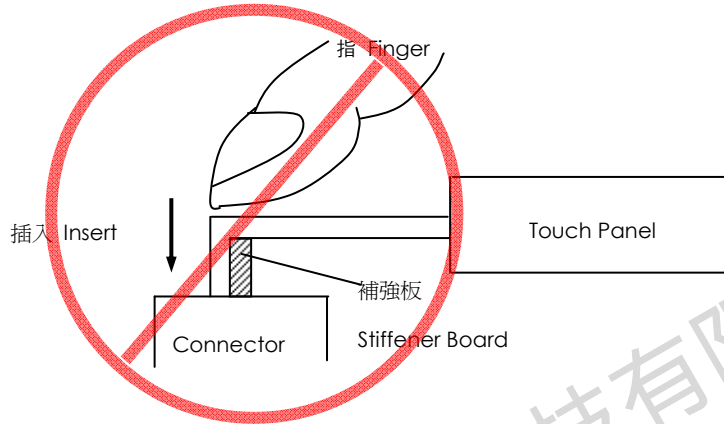

(8) 在實際組裝設計時，請注意以下事項。

Please pay attention for the matter as stated below at mounting design of touch panel & enclosure

-1. 觸控面板的上蓋支撐物請設定在透明範圍的外側。

(上蓋請勿壓在透明範圍上，會有誤動作的情況發生)

Enclosure support to fix touch panel must be out of view (transparent) area. (Do not design enclosure presses the view area to protect from miss input)

-2. 上蓋的外框請設定在透明範圍的內側、動作保證範圍的外側。

(上蓋的外框請勿接觸到透明範圍)。

Enclosure edge must be between view area & Guaranteed active area. (Enclosure edge must not touch with view area)

-3. 觸控面板上下部的壓合，請以橡膠等彈性材質。

We recommend the material of support to fix touch panel is elastic material.

原圖管理元
↑
日付

					Title: Touch Panel Spec.	
					Draw No. Tech Bes TTI-13031	Cust
ED	Date	Design	Check	Description		富晶通科技股份有限公司
Des	20140408	Cloud	Chk	App.		Transtouch Technology Inc.
					SHEET	14/19

- 4. 使用時，觸控面板的上面(FILM)請勿與上蓋黏著固定。
Do not bond top surface (film) of touch panel with enclosure.
- 5. 觸控面板上部的邊角，因為玻璃導電層有傳導性，在組裝設計時請注意不要與金屬材質接觸。
The corner parts (fig.*) has conductivity. Do not touch any metal part after mounting.
- 6. 有防水需求時，請考慮用橡膠等材質對迴路週邊做防水。
Special design is required for water resistance use.
- 7. 當使用 Air gun 向觸控面板吹氣時，建議 Air 壓力調整為 2kg/cm² 以下，並且勿從玻璃側朝 FPC 直接吹氣，以免 FPC 在強烈 Air 壓力下，造成脫落。
Cleaning Touch panel by Air gun, pressure 2kg/cm² below is suggested.
This is preventing FPC to peel off when air is blowing to FPC from glass side.

【實裝構造例 Mounting condition example】

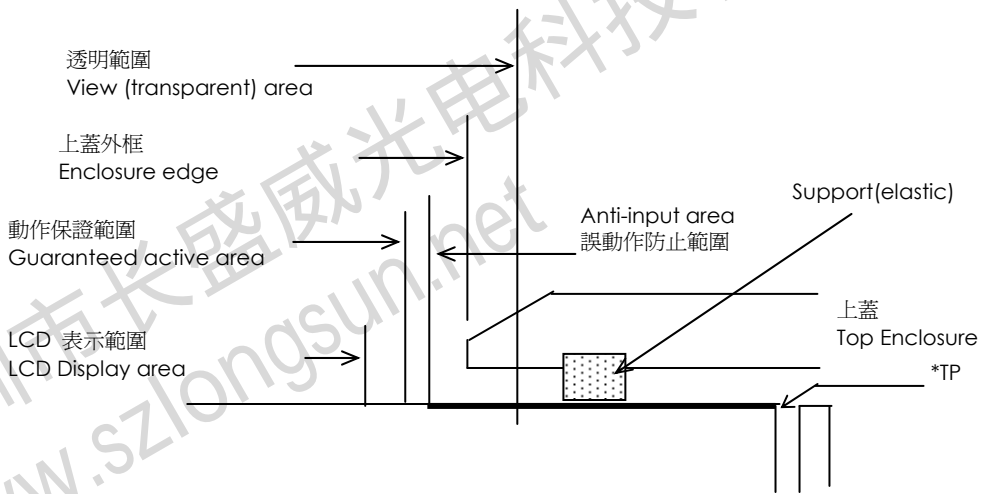

原圖管理元

日付

↑

					Title: Touch Panel Spec.	
					Draw No. Tech Bes TTI-13031	
					Cust	
ED	Date	Design	Check	Description		
Des	20140408	Cloud	Chk		App.	
					富晶通科技股份有限公司 Transtouch Technology Inc.	
					SHEET	15/19

-8. 必須在靠近 FPC 位置處預留 FPC 線路空間, 絕對避免外殼或其他零件碰觸或擠壓 FPC, 造成 FPC 脫落. 建議機構預留 4mm 以上組裝空間, 請參考實裝構造圖.

The mounting structure must has a reserved space for the FPC tail and never touch or squeeze the FPC by case or another components preventing FPC to peel off. Assembly space is recommended at least 4mm. Refer to mounting condition example 2 & 3.

【實裝構造例 Mounting condition example 2】

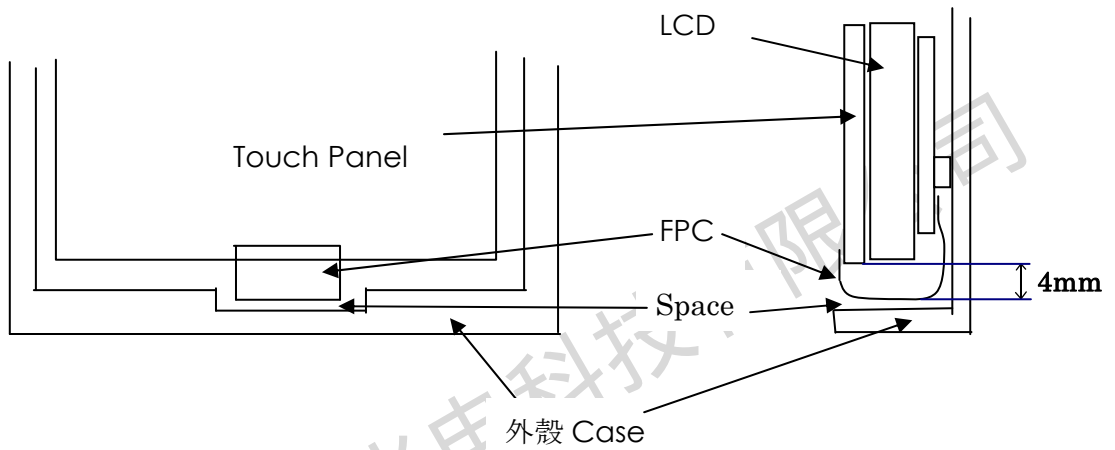

【實裝構造例 Mounting condition example 3】

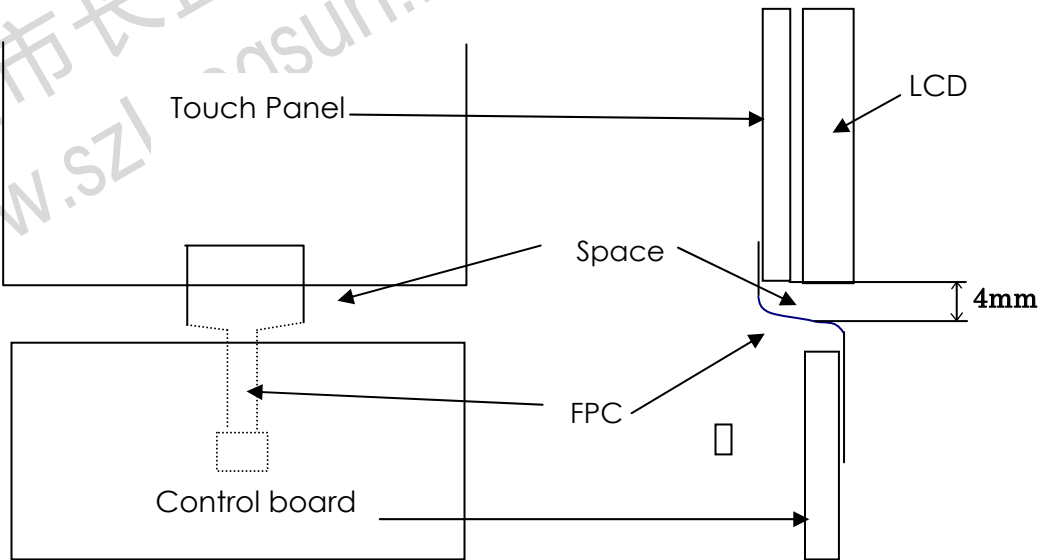

原圖管理元
↑
日付

					Title: Touch Panel Spec.	
					Draw No. Tech Bes TTI-13031	Cust
ED	Date	Design	Check	Description		富晶通科技股份有限公司 Transtouch Technology Inc.
Des	20140408	Cloud	Chk	App.		
					SHEET	16/19

A

B

C

D

A

B

C

D

E

F

-9.Touch Panel 本體一般保固一年,如有客戶特殊需求者依雙方另外制定標準。

Touch Panel has a year's guarantee. If the customer have special request, we can make a contract for it.

-10.VA 區及誤輸入防止區的界線上禁止外力擠壓與操作書寫,避免 ITO Crack 導致線性偏移。

Avoid operating or writing on VA/Anti-Input Area ,to prevent ITO cracking. That will make a Linearity NG.

深圳市长盛威光电科技有限公司
www.szlongsun.net

原圖管理元	↑
日付	

					Title: Touch Panel Spec.	
					Draw No. Tech Bes TTI-13031	
					Cust	
ED	Date	Design	Check	Description		
Des	20140408	Cloud	Chk		App.	
					富晶通科技股份有限公司 Transtouch Technology Inc.	
					SHEET	17/19

1 2 3 4

9. 包裝型式 Packing Method :

如圖 as drawing

製品(Film 面保護膜) →
Product(Film side with protective sheet)

1 個 Tray 盤可裝 4 片觸控面板
A tray with 4 pieces of touch panels

16 Tray 盤裝入一個內裝箱
An inner box with 16 pieces of trays

2 Inner Box and Cushion ↓ 內裝箱 2 個 + 緩衝

1 個裝滿的外裝箱內含 120 片觸控面板
A full outer box with 120 pieces of touch panels

原圖管理元
↑
日付

					Title: Touch Panel Spec.	
					Draw No. Tech Bes TTI-13031	
					Cust	
ED	Date	Design	Check	Description		
Des	20140408	Cloud	Chk		App.	
					富晶通科技股份有限公司 Transtouch Technology Inc.	
					SHEET	18/19

原稿保存於商品技術至少 13 年

TTIR0670304

包裝箱外側兩邊以圖章打印綠色『RoHS』字樣

Two green RoHS marks stamped on both side of one full carton

A

A

RoHS

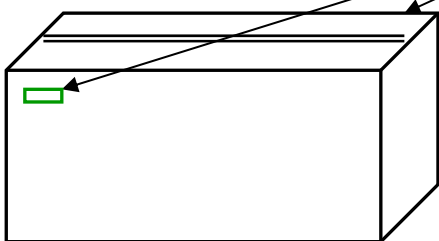

B

B

C

C

D

D

深圳市长盛威光电科技有限公司
www.szlongsun.net

原圖管理元	↑
日付	

E

					Title: Touch Panel Spec.	
					Draw No. Tech Bes TTI-13031	
					Cust	
ED	Date	Design	Check	Description		
Des	20140408	Cloud	Chk		App.	
					富晶通科技股份有限公司 Transtouch Technology Inc.	
					SHEET	19/19

F

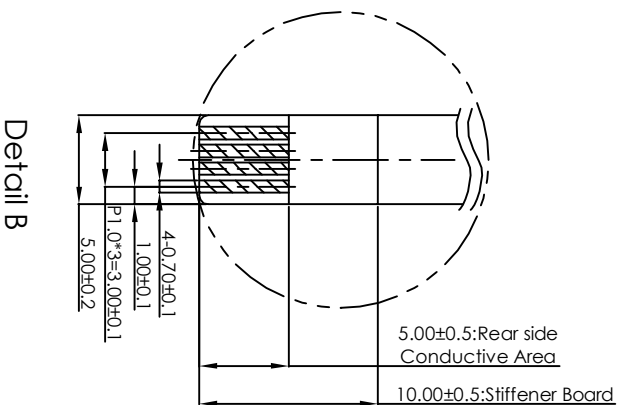
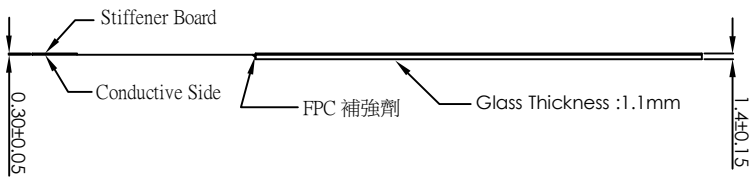
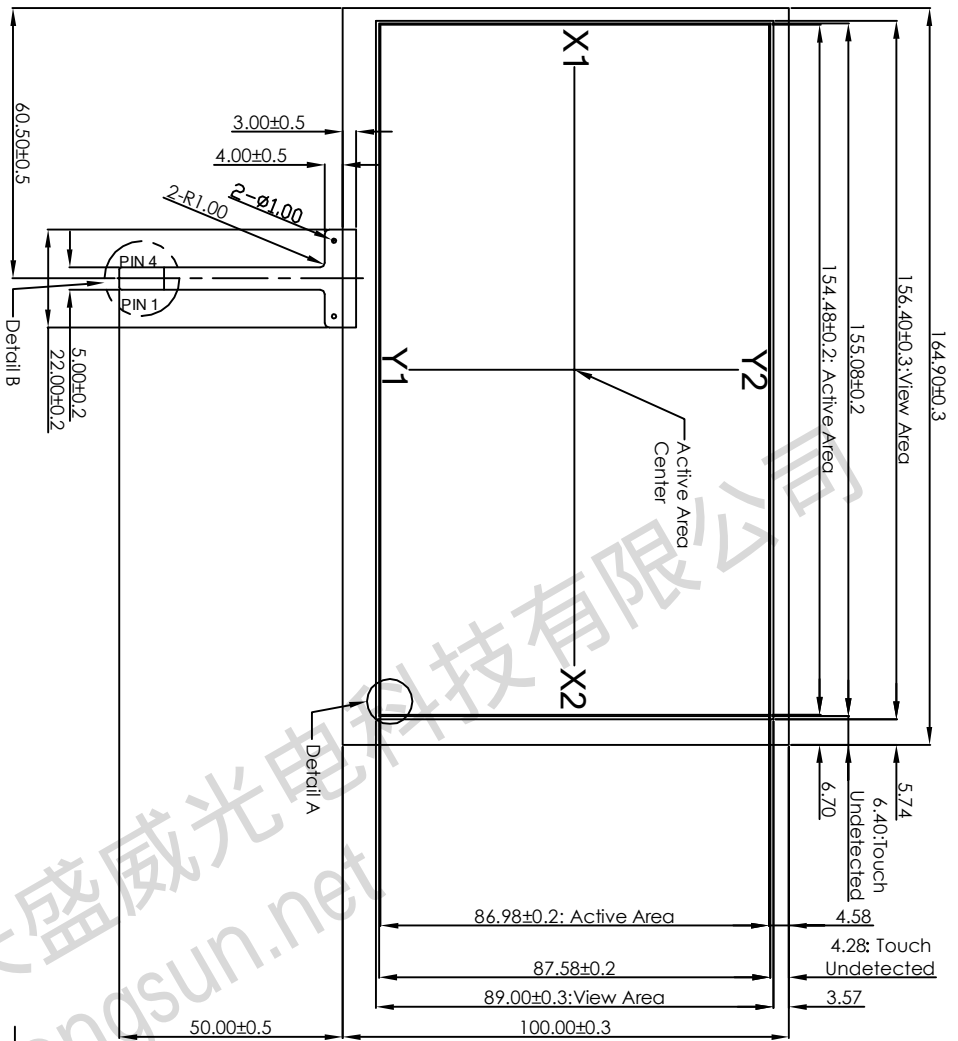

- Note:
1. Tolerance : ± 0.5
 2. Finger & Pen Input Type
 3. Surface Hardness: 3H
 4. Transmittance: 85% Typ. (JIS-K7105)
 5. Film: Anti-glare

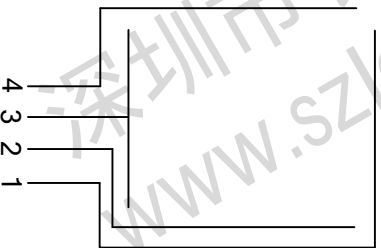
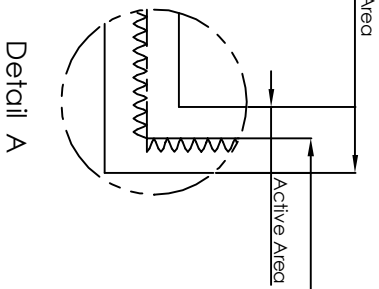

Connector Pin Assignment

Pin No.	Description
1	Y2
2	X2
3	Y1
4	X1

日期	原圖管理元
----	-------

名稱	TOUCH PANEL	比例	1:1
圖號	Tech Bes TI-13031	圖號	1/1
製圖	雷品通科技股份有限公司	製圖	
審核		審核	
日期	2013/07/24	日期	
地址	深圳市福田区	地址	
電話		電話	
傳真		傳真	
郵箱		郵箱	
網址		網址	
圖名	TOUCH PANEL	圖號	Tech Bes TI-13031
圖號		圖號	
製圖		製圖	
審核		審核	
日期		日期	
地址		地址	
電話		電話	
傳真		傳真	
郵箱		郵箱	
網址		網址	